

Article number: 40600700802465

Description: Helical gearbox
C702F-8-P200B5

Measures

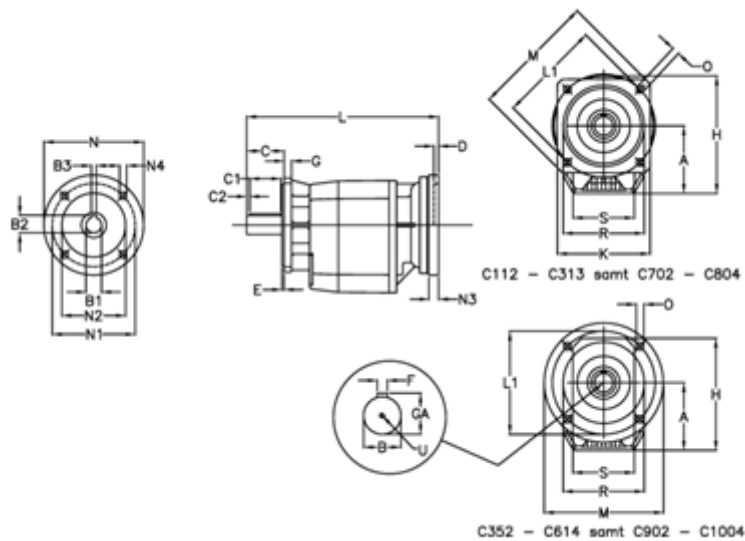

A = 208.0	D = 7.0	L1 = 300	R = 262
B = 60	E = 5	M = 350	S = 250
B1 = 55	F = 18	N = 400	U = M20x42
B2 = 59.3	G = 17	N1 = 350	
B3 = 16	GA = 64.0	N2 = 300	
C = 120	H = 358.0	N3 = 0	
C1 = 90	K = 300	N4 = M16x25	
C2 = 15	L = 600.0	O = 18.0	